

# RSH + SONOS AMP

## CUSTOM RACKSHELVES

These RSH shelves were designed in partnership with Sonos to provide you with the ultimate mounting solution. They come equipped with shelf mounted lacing bars for cable management, clamping bars to secure your Sonos Amps and an anodized faceplate, all in a single part #.

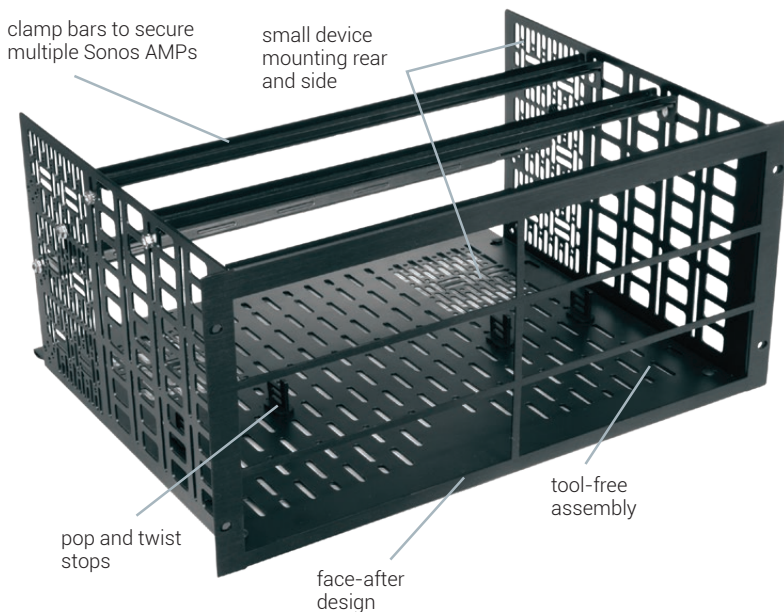

## FEATURES

- Shelf face is specifically designed for the Sonos Amp
- Unique 'face-after' design allows for easy installation and switch out of components
- Includes lacing bars for cable management
- Includes clamping bars to keep Sonos Amps secure
- Patented Tool-free shelf assembly in seconds
- Add components and manage cables effectively using the patented universal mounting pattern
- Pop and twist rear stop brackets enable quick and fine adjustment of component positioning
- Fully ventilated ears and bottom promote cooling airflow
- Black brushed and anodized finish

WHAT GREAT SYSTEMS ARE BUILT ON.™

A brand of **legrand**

**MA**  
Middle Atlantic Products

# RSH + SONOS AMP

## CUSTOM RACKSHELVES

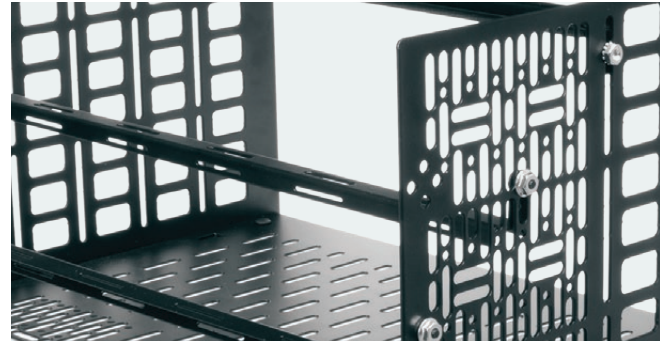

PART #	DESCRIPTION	# OF RU	# OF SONOS AMPS
RSHA-SONOS-AMP2	2RU RSH shelf for (2) Sonos Amps with tool-free assembly. Faceplate, cable management and clamp bars included.	2	2 Units
RSHA-SONOS-AMP4	4RU RSH shelf for (4) Sonos Amps with tool-free assembly. Faceplate, cable management and clamp bars included.	4	4 Units
RSHA-SONOS-AMP6	5RU RSH shelf for (6) Sonos Amps with tool-free assembly. Faceplate, cable management and clamp bars included.	5	6 Units

NOTE(S):  
 1) ALL DIMENSIONS IN FORMAT:  
 INCHES [MILLIMETERS]  
 2) BLACK BRUSHED AND ANODIZED FINISH  
 3) SHOWN WITH SONOS MODEL # AMP INSTALLED

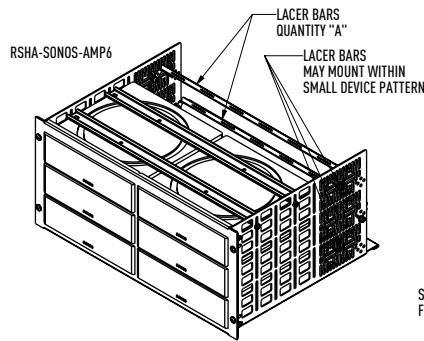
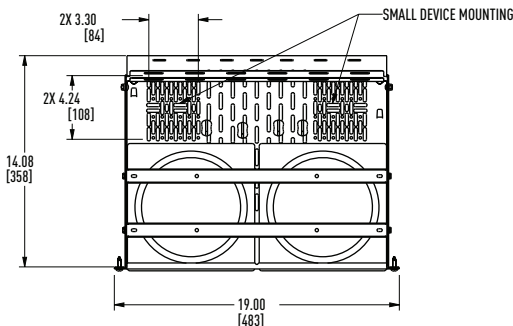

SHOWN WITH FOUR STOPS  
RSHA-SONOS-AMP6

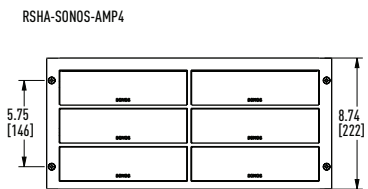
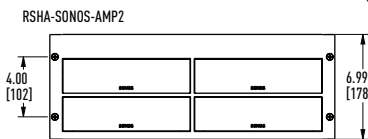
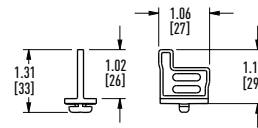
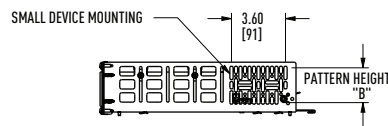

MODEL NUMBER	RACK SPACES	HEIGHT	# OF SONOS AMPS	# OF LACER BARS "A"	PATTERN HEIGHT "B"
RSHA-SONOS-AMP2	2 RU	3.49 [89]	21	1	2.32 [59]
RSHA-SONOS-AMP4	4 RU	6.99 [178]	42	2	5.61 [142]
RSHA-SONOS-AMP6	5 RU	8.74 [222]	63	2	7.63 [194]

### CORPORATE HEADQUARTERS

300 Fairfield Road  
 Fairfield, NJ 07004, U.S.A.  
 Voice: 800-266-7225  
 Fax: 800-392-3955  
 International Voice: +1 973 839-1011  
 International Fax: +1 973 831-4982  
 middleatlantic.com

### CANADA

113 Iber Road, Ottawa,  
 Ontario K2S 1E7  
 Voice: 888-766-9770  
 Fax: 888-599-5009  
 middleatlantic.ca

### FACTORY DISTRIBUTION

USA: New Jersey • California • Illinois  
 Canada: Ontario

## COMPLEMENTARY PRODUCTS



HSK



FTA-3



TA

WHAT GREAT SYSTEMS ARE BUILT ON.™

A brand of **Legrand**