

**HEY YOU,
LET ME
HELP!**

CONTENT

Contents	2
Important information.....	3
Important safety precautions.....	4
Standard accessories	8
Vesa mount installation.....	9
Control panel	10
Connection panel.....	11
Connections	12
Remote control	14
Basic operations	15
OTA update	18
Operating the navigation menu.....	19
2 Operating the quick launcher.....	20
Pre- installed apps.....	21
Setting menu	22
Troubleshooting.....	25
Specifications	26

IMPORTANT INFORMATION

If the unit is not positioned in a stable location, it can be potentially hazardous due to falling. Many injuries, particularly to children, can be avoided by taking simple precautions such as:

- Only use furniture that can safely support the unit.
- Ensure the CTOUCH interactive display is not hanging over the edge of the supporting furniture.
- Do not place the CTOUCH interactive display on tall furniture (for example, cupboards or bookcases) without anchoring both the furniture and the CTOUCH interactive display to a suitable support.
- Do not place cloth or other materials between the CTOUCH interactive display and supporting furniture.
- Do not let children climb on furniture to reach the CTOUCH interactive display or its controls.
- Do not use immediately after moving from a low temperature to high temperature environment, as this causes condensation, which may result in fire, electric shock, or other hazards.
- To avoid possible condensation it is recommended to not use the device within 24 hours after its arrival, to avoid possible condensation.

3

Warning!

To prevent the spread of fire, keep candles or other open flames away from the CTOUCH interactive display all the times.

IMPORTANT SAFETY PRECAUTIONS



CAUTION

**RISK OF ELECTRIC SHOCK
DO NOT OPEN THE DISPLAY**



This symbol indicates dangerous voltage may pose a risk of electric shock for your CTOUCH interactive display. This label is located on the back of your CTOUCH interactive display.



This symbol indicates that important operating and maintenance instructions are contained in the literature accompanying your CTOUCH interactive display.

4

Electricity may cause personal injuries and property damage if handled improperly. The CTOUCH interactive display has been engineered and manufactured with the highest priority on safety. But IMPROPER USE CAN RESULT IN POTENTIAL ELECTRIC SHOCK OR FIRE HAZARD. In order to prevent potential danger, please observe the following instructions when installing, operating and cleaning the product. To ensure your safety and prolong the service life of your CTOUCH interactive display, please read the following precautions carefully before using the product.

1. **Read these instructions** - All operating instructions must be read and understood before the product is used.
2. **Keep these instructions** - These safety and operating instructions must be kept in a safe place for future reference.
3. **Note all warnings** - All warnings on the product and in the instruction manual must be observed closely.
4. **Follow all instructions** - All operating instructions must be followed.
5. **Attachments** - Only use attachments/accessories specified by the manufacturer. Do not use attachments which are not recommended by the manufacturer. Use of improper attachments can result in accidents.
6. **Power source** - This product is intended to be supplied with a listed power supply indicated on the marking label. If you are not sure of the type of power supply at your location, consult your product dealer or local power company. For added protection for this product during a lightning storm, or when it is left unattended and unused for a long period of time, unplug it from the wall outlet and disconnect the cable system.
7. **Power cord protection** - Protect the power cord from being walked on or pinched particularly at plugs, wall outlet, and the point where they exit from the device.
NOTE: Where the mains plug or an appliance coupler is used as the disconnected device, the disconnected device shall remain readily operable.
8. **Overloading** - Do not overload wall outlets, extension cords, or convenience receptacles on other equipment as this can result in a risk of fire or electric shock.
9. **Entering of objects and liquids** - Never insert an object into the product through vents or openings. High voltages are present in the product and inserting an object can cause electric shock and/or short circuit internal parts. For the same reason, do not spill water or liquid on the product.
10. **Servicing** - Refer all servicing to qualified service personnel. Servicing is required when the device has been damaged in any way, such as the power-supply cord or plug is damaged, liquid has been spilled, objects have fallen into the device, the device has been exposed to rain or moisture, does not operate normally or has been dropped.
11. **Damage requiring service** - If any of the following conditions occurs, unplug the power cord from the AC outlet and request a qualified service technician to perform repairs.
 - a. When the power cord or plug is damaged.
 - b. When liquid is spilled on the product or when objects have fallen into the product.
 - c. When the product has been exposed to rain or water.

d. When the product does not operate properly as described in the operating instructions.

Do not touch the controls other than those described in the operating instructions. Improper adjustment of controls not described in the instructions can cause damage, which often requires extensive adjustment work by a qualified technician.

e. If the product has been dropped or the cabinet has been damaged in any way.

f. When the product displays an abnormal condition or exhibits a distinct change in performance. Any noticeable abnormality in the product indicates that the product needs servicing.

12. **Replacement parts** – In case the product needs replacement parts, make sure that the service person uses replacement parts specified by the manufacturer, or those with the same characteristics and performance as the original parts. Use of unauthorized parts can result in fire, electric shock and/or other danger.
13. **Safety checks** – Upon completion of service or repair work, request the service technician to perform safety checks to ensure that the product is in proper operating condition.
14. **Wall or ceiling mounting** – When mounting the device on a wall or ceiling, be sure to install the product according to the method recommended by the manufacturer. This is a safety issue.
15. **Stand** – Use only with the trolley stand or wall mount specified by the manufacturer, or sold with the device. Do not place the product on an unstable trolley stand or wall mount. Placing the product on an unstable base can cause the product to fall, resulting in possible serious injuries as well as damage to the device. When mounting the product on a wall, be sure to follow the manufacturer's instructions. Use only the mounting hardware recommended by the manufacturer. Make sure you use all 4 bolts when placing a CTOUCH display on the Wallom2 lifts.
16. **Careful move** – When a trolley is used, be cautious when moving the trolley/device combination to avoid injury from the device tipping over. Sudden stops, excessive force and uneven floor surfaces can cause the product to fall from the trolley. Careful move and be careful please, point of strength should not in display screen. Never attempt to move the CTOUCH interactive display unless the AC power cord has been disconnected.
17. **Do not use this device near water** – for example near a bathtub, washbowl, kitchen sink, laundry tub, in a wet basement or near a swimming pool. The device should not be exposed to dripping or splashing liquids and that no objects filled with liquids, such as vases, shall be placed on the device. Do not use immediately after moving from a low temperature to high temperature environment, as this causes condensation, which may result in fire, electric shock, or other hazards.
18. **Clean only with damp cloth** – Unplug the device from the power before cleaning. Do not use liquid cleaners or aerosol cleaners. Use a soft cloth for cleaning. Please contact your dealer for our cleaning material or look at support.ctouch.eu for our cleaning recommendations.
19. **Ventilation** – Do not block any ventilation openings. Install the CTOUCH interactive display in accordance with the manufacturer instructions. The vents and other openings in the cabinet are designed for ventilation. Do not cover or block these vents and openings since insufficient ventilation can cause overheating and/or shorten the life of the product. This product is not designed for built-in installation; therefore do not place the product in an enclosed space such as a bookcase or rack, unless proper ventilation is provided or the manufacturer's instructions are followed. It should have interspace around the product and the wider it has the heat dissipation is better. Suggest up>10cm, around>10cm and back >2.5cm.
20. **Heat sources** – Do not install near any heat sources such as radiators, heat registers, stoves, or other device (including amplifiers) that produce heat.
21. **Panel protection** – The display panel used in this product is made of glass. Therefore, it can break when the product is dropped or impacted upon by other objects. Be careful not to be injured by broken glass pieces in case the display panel breaks. Do not use hard or sharp object to take place of special pen when write in the screen. Wipe the screen from one side to the other carefully till it looks completely clean. Do not flailing in all directions.
22. **Pixel defect** – The display panel is a very high technology product, giving you fine detailed pictures. Occasionally, a few non-active pixels may appear on the screen as a fixed point of blue, green or red. Please note that this does not affect the performance of your product.
23. **Placement of the display** – Do not use the display in Portrait mode nor horizontally, due to heating household. If done anyway, the warranty will void.

Warning! For continued safety, device with class I construction shall be connected to a mains socket outlet with a protective earthing connection.

ABOUT LOCATION / ENVIRONMENT

- When the unit is used in rooms (locations) with low temperature, the picture may leave trails or appear slightly delayed. This is not a malfunction. The unit will recover when the temperature returns to normal.
- Do not leave the unit in a hot or cold location. Also, do not leave the unit in a location exposed to direct sunlight to near a heater or in high humidity, as this may cause the cabinet to deform and the screen to malfunction and affect the CTOUCH interactive display's performance.
- Environment condition:
 - Operating temperature: 5°C – 35°C
 - Operating humidity: 20% – 80% (no moisture condensation)
 - Storage temperature: -15°C – 45°C
 - Storage humidity: 10% – 80%
 - Atmospheric pressure: 86 kPa – 106 kPa

6

ABOUT AFTER-IMAGE

The extended use of fixed image program material can cause a permanent after-image on the screen. This background image is viewable on normal programs in the form of a stationary fixed image. This type of irreversible screen deterioration can be limited by observing the following steps:

- A. Reduce the brightness/contrast setting to a minimum viewing level.
- B. Do not display the fixed image for extended periods of time.
- C. Turn the power off when the display is not in actual use.

Important Information Regarding Use of Video Games, Computers, Captions or Other Fixed Image Displays.

- Do not allow a still picture to be displayed for an extended period of time, as this can cause a permanent after-image to remain on the screen. Examples of still pictures include logos, video games, computer images, teletext and images displayed in 4:3 mode.

Cautions!

- The permanent after-image on the screen resulting from fixed image use is not an operating defect and as such is not covered by the warranty.
- This product is not designed to display fixed images for extended periods of time.

Cleaning and Maintenance

To clean this unit, wipe with a soft, dry cloth. Clean the cabinet with a soft, lint-free cloth. If the cabinet is especially dirty, moisten a soft, lint-free cloth in a weak detergent Solution, squeeze the excess moisture from the cloth, then wipe the cabinet with the cloth.

- Use a clean cloth to dry the cabinet.
- Use eyeglass cleaner to remove stubborn dirt from the screen.
- Never use alcohol, paint thinner or benzine to clean this device.

Carrying or Moving the CTOUCH interactive display

7

- When you move the CTOUCH interactive display, hold the frame of the CTOUCH interactive display .
- Be aware of the danger or harm which may be caused by carrying or moving the CTOUCH interactive display, as the bezel is very thin.
- When transporting, do not subject the unit to shocks or vibration, or excessive force.

Environmental Protection

The CTOUCH display should not be disposed of with household waste. Please recycle where facilities exist. Or contact CTOUCH to return your CTOUCH display free of charge.

STANDARD ACCESSORIES

Unpacking

The following items are included in your product box.

8

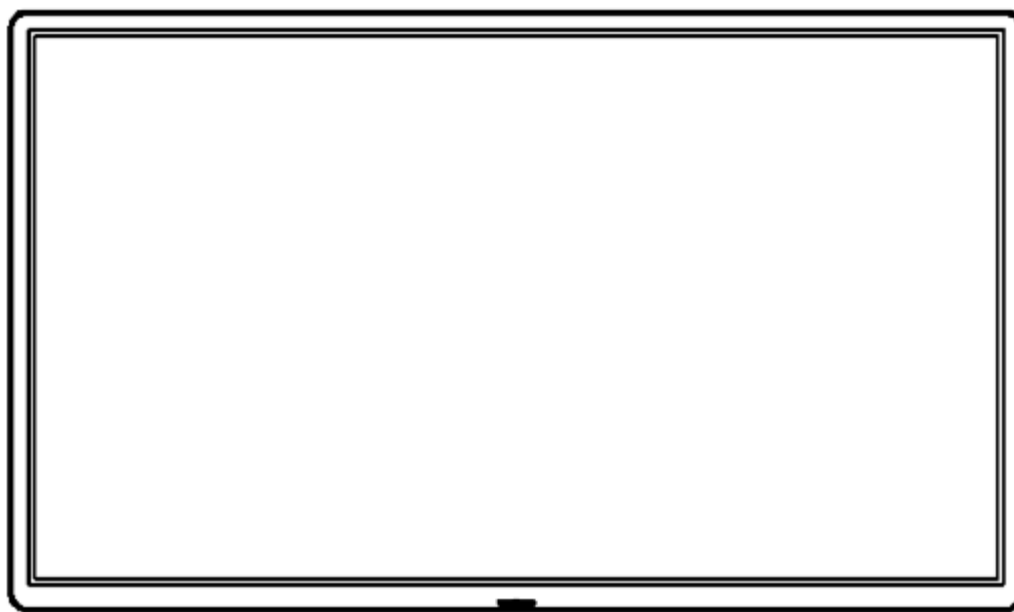

CTOUCH interactive display



Remote Control



2 CTOUCH Pens

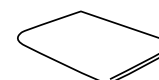

Cleaning Cloth



AC Power Cord



UK AC Power Cord

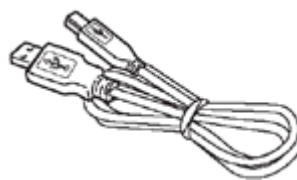

USB Touch Cable

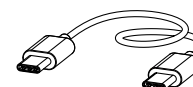

USB-C Cable



HDMI Cable



Quick Start Guide



Warranty Card



Welcome Letter

Note: the illustrations may differ slightly from the items shipped with your products.

VESA MOUNT INSTALLATION

1. Contact a professional for assistance when mounting the CTOUCH interactive display.
CTOUCH is not responsible for any damage to the product or injury to yourself, if you mount the CTOUCH interactive display on your own.
2. Do not mount the CTOUCH interactive display while the CTOUCH interactive display is turned on.
It may cause personal injury due to electric shock.
3. Use standard M8 x 25mm screws (4 pieces) to mount the CTOUCH interactive display.

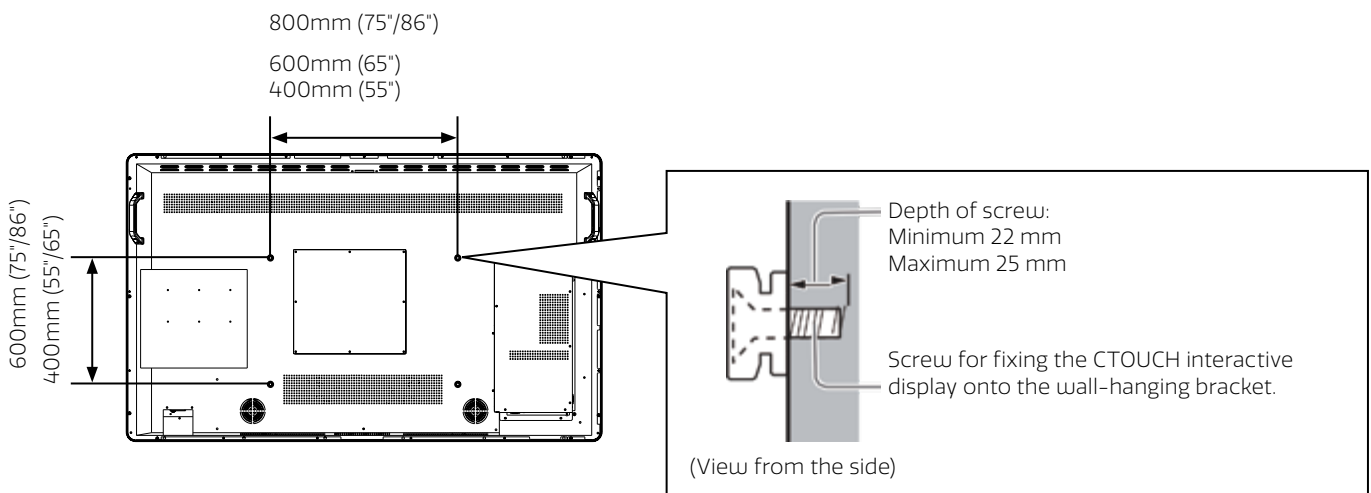

9

Warning!

- Always be sure to ask a qualified technician to carry out set up. Incorrect fitting may cause equipment to fall, resulting in injury and product damage. Any damage resulting from not having a professional installer mount your unit will void your warranty.
- When any optional accessories or brackets are used, always ensure that the instructions provided are followed fully.
- Do not mount the unit directly below ceiling lights (such as spotlights or halogen lights) which typically give off high heat.
- Take care when fixing wall brackets to the wall. Wall mounted equipment shall not be grounded by metal within the wall. Always ensure that there are no electrical cables or pipes in the wall before hanging bracket.

CONTROL PANEL

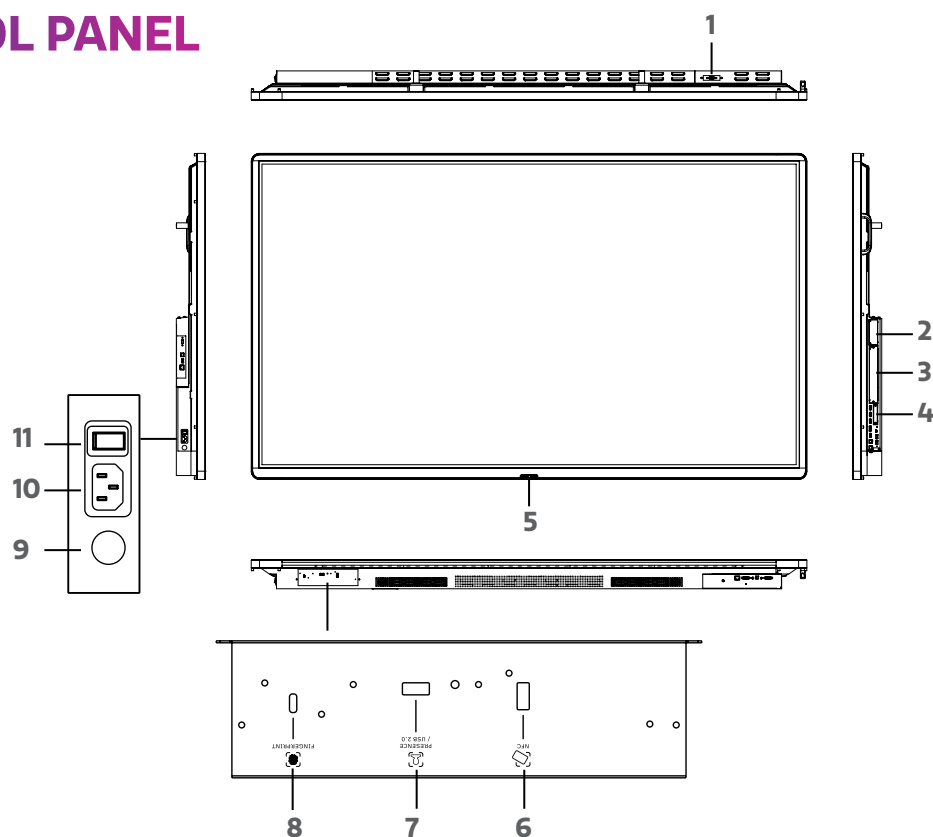

10

NR.	DESCRIPTION	
1	USB (3.0) (for camera)	This port is designed for connecting a webcam.
2	CTOUCH module slot	Insert an CTOUCH module (optional).
3	OPS module slot	Insert an OPS module (optional).
4	Wi-Fi module slot	Insert a Wi-Fi module (optional).
5	CTOUCH Button	Power LED Red: In standby mode. Blue: In power on mode.
		Remote control sensor Aim the remote control towards this spot on the CTOUCH interactive display.
		Power Press the button for about 2 seconds to turn the CTOUCH interactive display on or off.
		Navigation Bar control Press the button once to call up the Navigation Bar.
6	NFC reader port	Insert the CTOUCH NFC reader (optional). Note: this port is dedicated to the NFC reader, normal USB device will not work.
7	USB 2.0/Human Presence Detection port	Insert the CTOUCH Human Presence Detection module (optional). Note: this port will also work with USB devices.
8	Fingerprint scanner port	Insert the CTOUCH fingerprint scanner (optional). Note: this port is dedicated to the fingerprint scanner, normal USB device will not work.
9	Fuse	12A 250V
10	AC IN	Plug the AC cord into this jack and into a power outlet.
11	Power Switch	Push (I) to turn on the power, push (O) to cut off the power. Note: for safety reasons do not cover the power switch.

CONNECTION PANEL

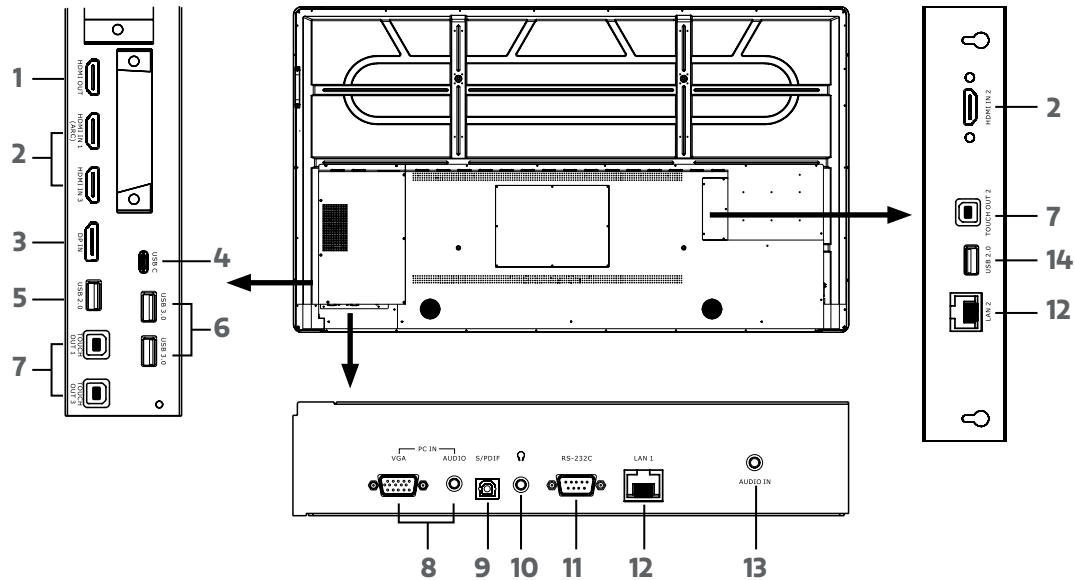

11

NR.	DESCRIPTION
1	HDMI out Connect an external device with a HDMI cable to this port to output the image and sound of the CTOUCH interactive display.
2	HDMI 1/2/3 in Connect an external device with a HDMI cable to this port. Note: connect an external HDMI device which supports ARC to HDMI 1.
3	Display Port (DP) in Connect an external device with a DP cable to this port.
4	USB-C Connect an external device with an USB-C cable to this port. Note: the display supports USB 3.1 Gen 2.
5	USB 2.0 Connect a USB device to this port for Android. Note: use this USB-port for manual firmware updates.
6	USB 3.0 Connect a USB device to this port for OPS or Android.
7	Touch out 1/2/3 Connect an external device to support touch control of the external device on the display. Note: Windows is Plug & Play, for Apple gestures a driver is needed. Note: Touch out 1 connects to HDMI 1, Touch out 2 connects to HDMI 2 & Touch out 3 connects to HDMI 3, DP & VGA.
8	VGA in Connect an external device with a VGA cable and Mini Jack to this port.
9	SPDIF out Connect a digital sound system to this SPDIF jack.
10	Headphones in Connect a headphone to this jack.
11	RS-232C Connect a DB-9 cable to this port for remote control, service and other uses.
12	LAN 1/2 Connect the external network or router with an LAN cable to this port.
13	Audio in Connect an external audio device with a Mini Jack cable to this jack.
14	USB 2.0 Connect a USB device to this port for OPS and Android.
	Note: for all audio devices the selected source is audible.

CONNECTIONS

CAUTIONS BEFORE CONNECTING

- Please make sure the CTOUCH display is turned off then connecting an external device.
- Check the plugs at the ends of the cables to make sure that they are the correct type before plugging them into the jacks of the CTOUCH interactive display.
- Make sure that all plugs are securely inserted into the jacks. Loose connections can result in image or color problems.
- The illustration of the external device may be different depending on your model.
- Refer to the operating manual of the external device as well.

12

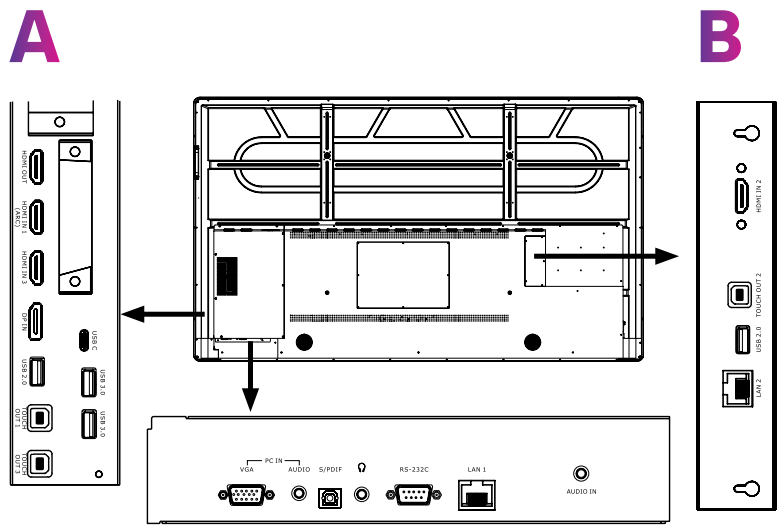

C

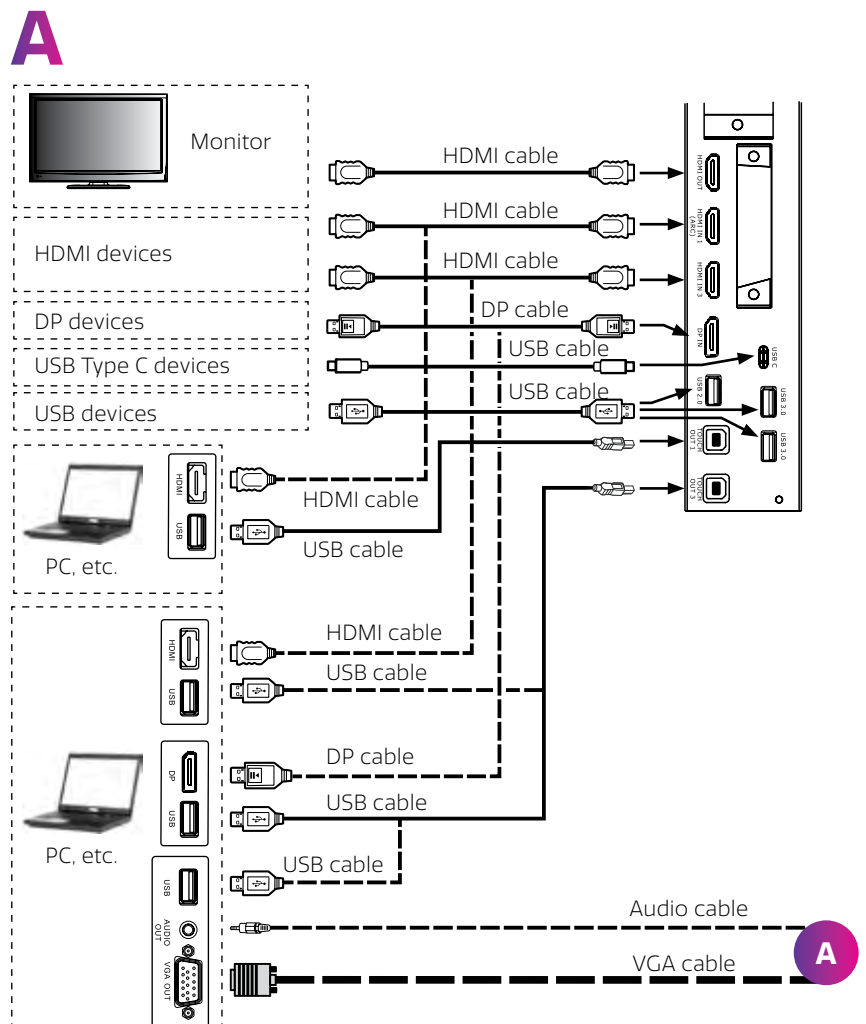

B

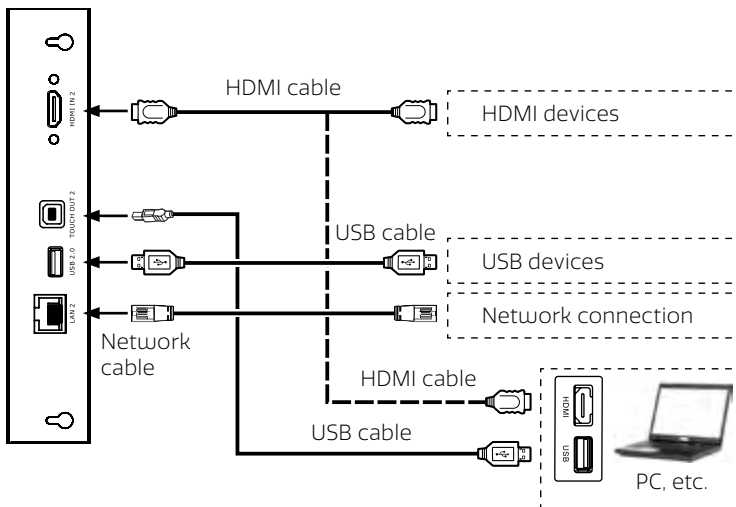

- ⊕ Connect TOUCH OUT with USB cable to PC USB port.
- ⊕ Connect PC with VGA cable, HDMI cable or DP cable. Please choose the proper method of connection based on your device.(Only for PC, HDMI, DP signal)
- ⊕ Touch out 1 corresponds to the HDMI 1.
- ⊕ Touch out 2 corresponds to the HDMI 2.
- ⊕ Touch out 3 corresponds to the HDMI 3, DP or VGA.
- ⊕ **Note:** After installation of the driver, it can control the external computer by native touch control.

13

C

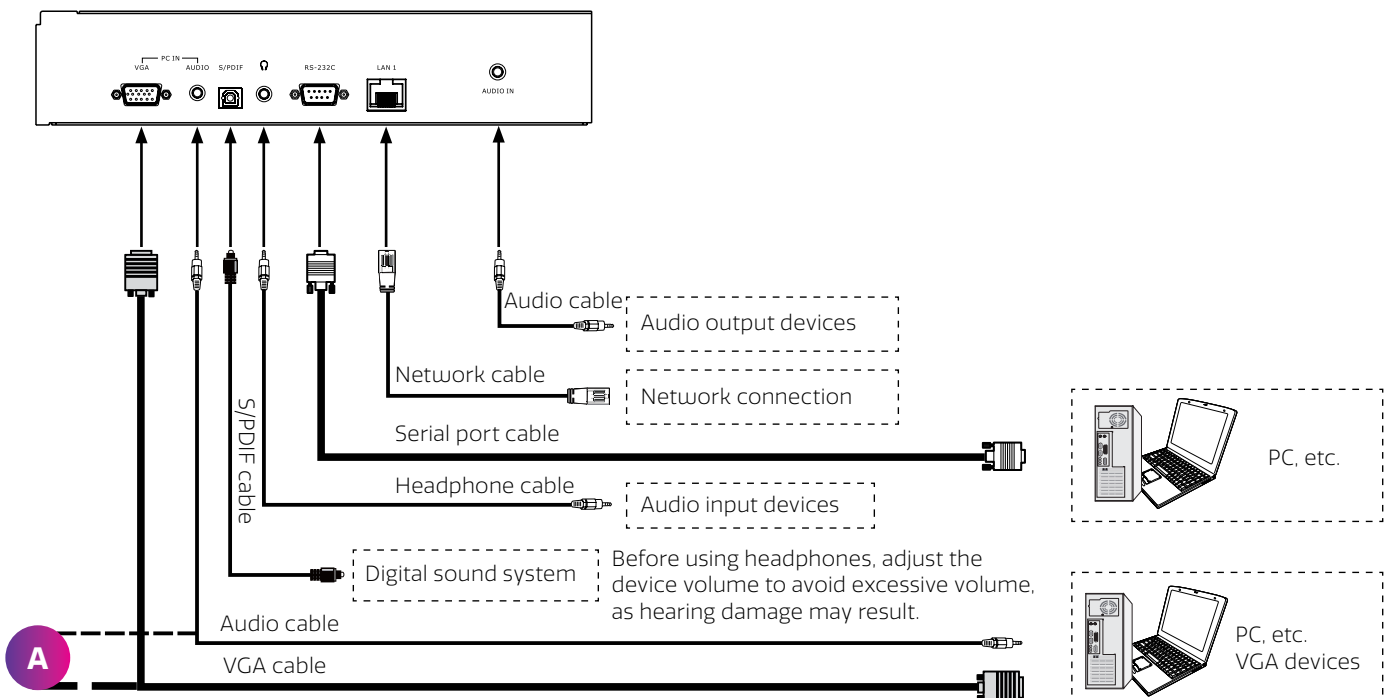

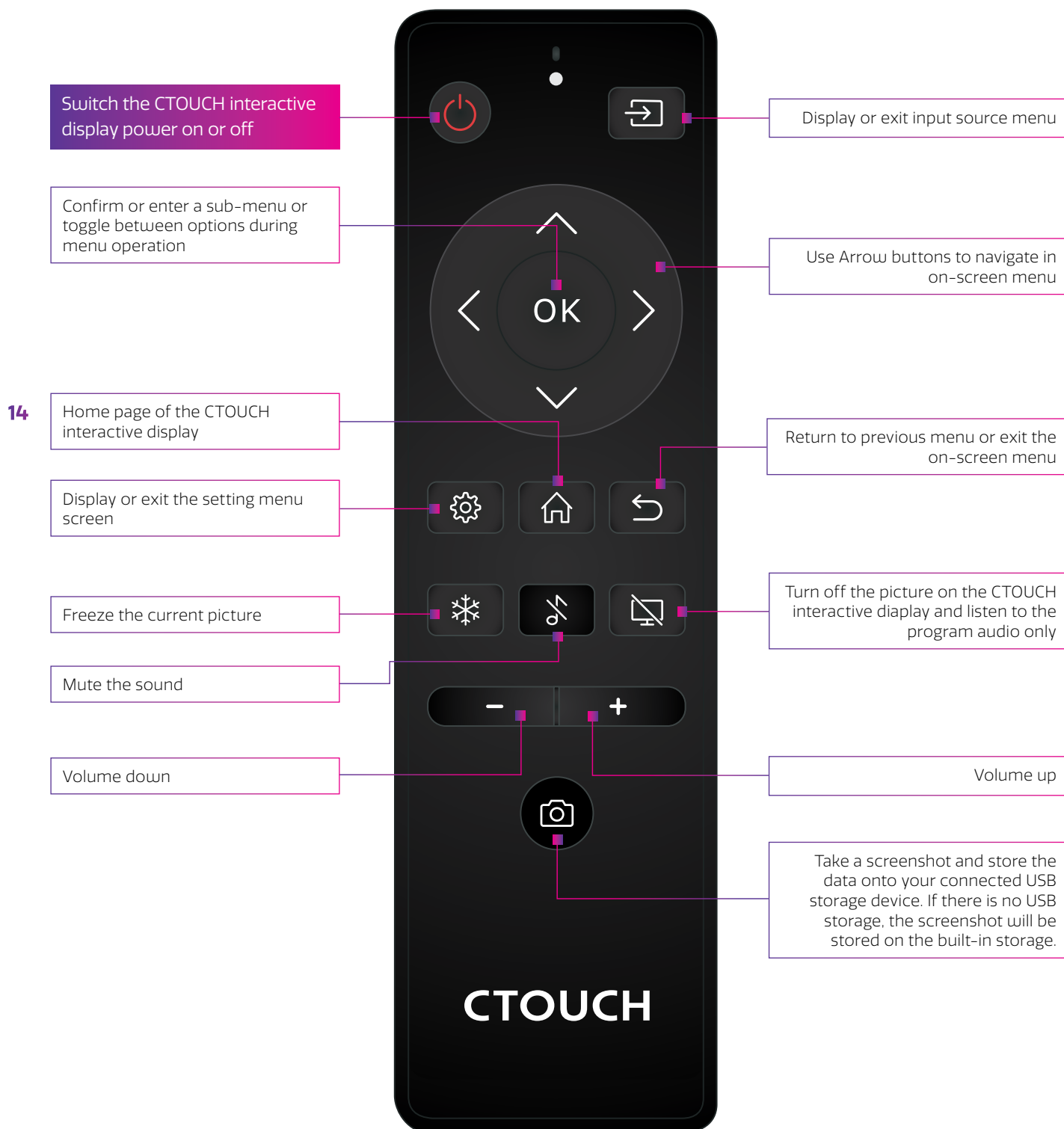

REMOTE CONTROL



* The function differs depending on the model you have.

BASIC OPERATIONS

TURNING THE CTOUCH INTERACTIVE DISPLAY ON OR OFF

1. Plug one side of the power cord into the AC power outlet and the other side into the wall socket.
2. Switch on the Power Switch to turn the CTOUCH interactive display on.
3. The display is in standby mode now. Wait a moment until the power indicator lights up, then press  button on the remote or the CTOUCH button on the display, to turn the CTOUCH interactive display on.
4. Press  button on the remote or the CTOUCH button on the display again, to turn the CTOUCH interactive display in standby mode.
5. Switch off the Power Switch to cut off the power completely.

Note: The CTOUCH interactive display needs some time to shut off correctly before it can be switched on again. By interrupting this process the next start up can take longer.

Note: When there is no active source on the CTOUCH interactive display, it will go into stand-by mode after 3 minutes.

15

CONNECTIONS

Make sure both the external device as well as the CTOUCH display are turned off, when connecting the external device to the CTOUCH display.

Check the plugs at the ends of the cables to make sure that they are the correct type, before plugging them into the jacks of the CTOUCH interactive display.

CONNECTING TO WIRED INTERNET

Plug the LAN-cable into the LAN-port on the bottom or side of the CTOUCH display, to connect to the internet.

FIRST TIME INSTALLATION

When turning on the CTOUCH display for the first time, the below shown installation menu pages will appear on the screen.



16

Select the desired menu language. Press **START** to go to the next page.

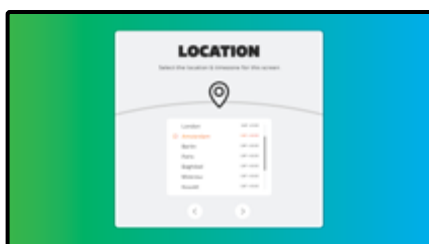

Select your location and press **NEXT** to go to the next page.



Select your required Energy Mode and press **NEXT**.



Select the model you have (depending on the BRIX module that is delivered with the display).



Follow the steps on the screen to connect your display to the internet.



The display will check if there is an update available. After this step the installation is **finished**.

OTHER QUESTIONS

Press the CTOUCH home button and then press on the 'I'-icon to open the onboard manual.

Or visit **support.ctouch.eu**.

CONNECTING TO WIRELESS INTERNET

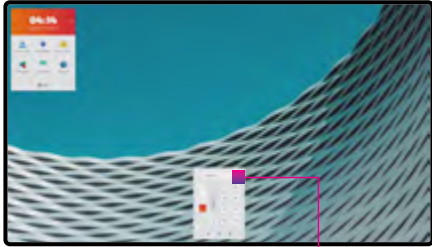

Click on the Setting Menu icon in the Float bar



Click on Wi-Fi



Turn the Wi-Fi on by touching the **on/off button** on the right upper side

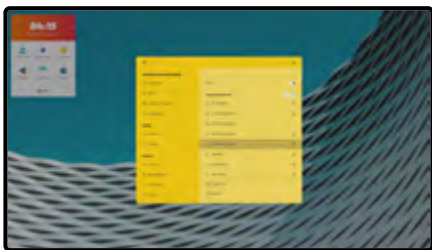

Select the requested Wi-Fi network

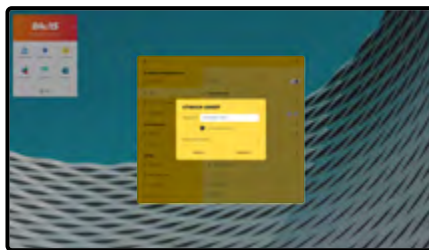

Fill in the password and select 'connect'

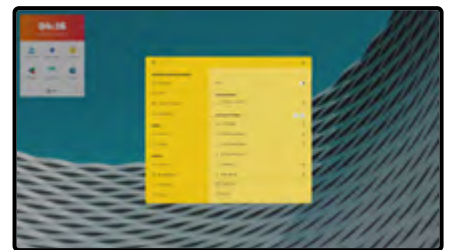

The connection is set if you see **'connected'** underneath the connected network

OTA UPDATE

When you connect your display to the internet, a notification will appear when a new firmware update is available.

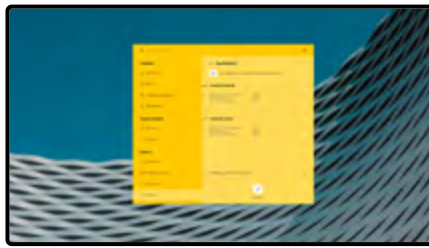
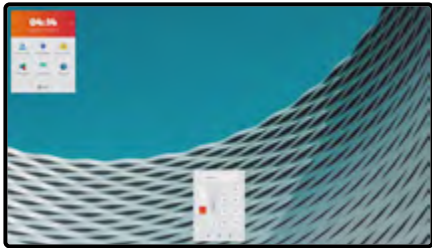

Select the option you like.

Yes = See next photo.

No = The notification will not appear again until the next firmware update.

18

Later = The next time you turn on the display the notification will appear again.

Press on 'Download' to

download the firmware







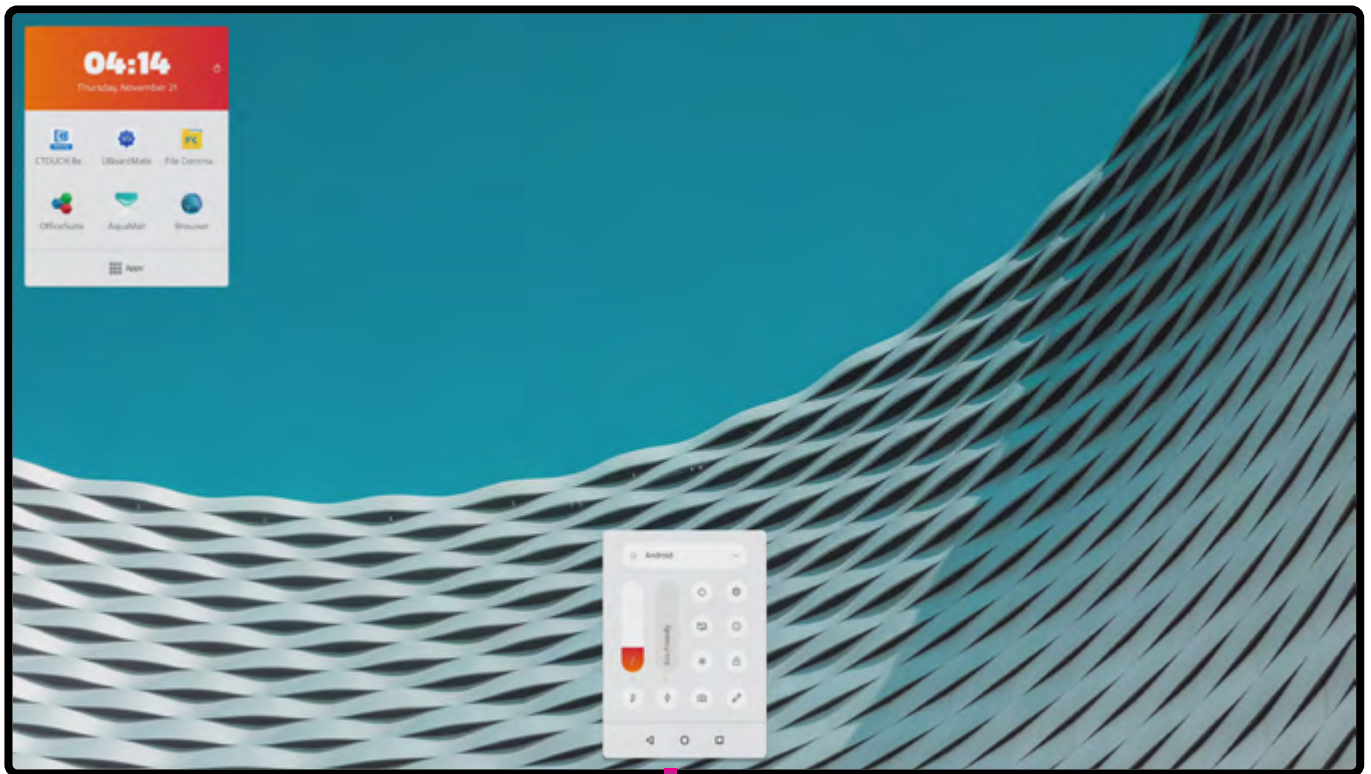







update. After the download is complete, the installation will start automatically. This will take about 10 minutes.

OPERATING THE NAVIGATION MENU

Press the CTOUCH button, slide up from the bottom of the screen with two fingers or long press on the screen with five fingers to call up the Float Bar.



19

- | | | | | | |
|---|-------------|---|-------------------------|---|---------------------|
|  | Source menu |  | Backlight mute function |  | Lock touch |
|  | Volume bar |  | Freeze image |  | Annotation tool |
|  | Mute/Unmute |  | Screenshot function |  | Previous screen |
|  | Energy mode |  | Settings menu |  | Home page |
|  | Power off |  | User manual |  | Application history |

OPERATING THE QUICK LAUNCHER

20

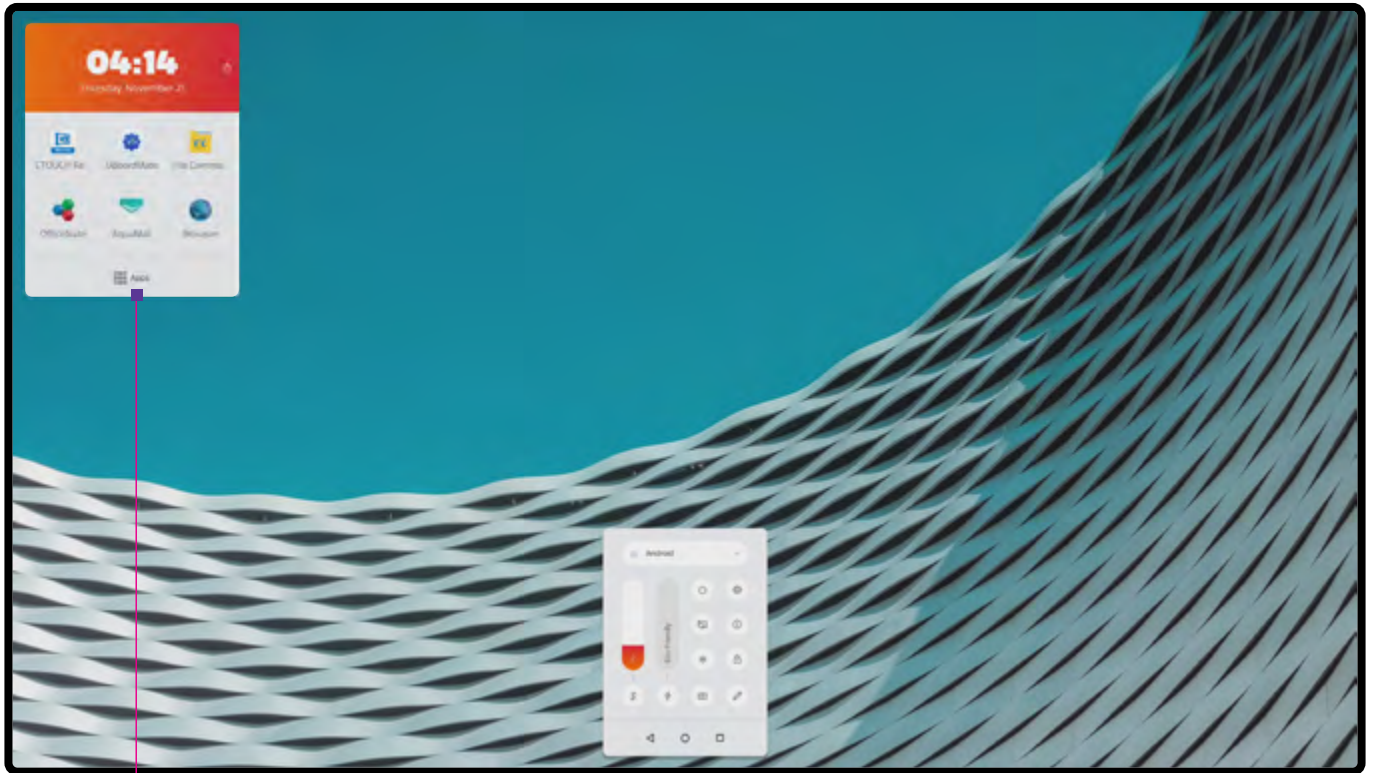

Clock

04:14

Thursday, November 21

Favorite apps

The favorite apps can be changed by press and hold the icon for 3 seconds.

CTOUCH Re... UBoardMate File Comma...

OfficeSuite AquaMail Browser

Apps











Timer

If the timer is running, the color will be green. You can switch back to the clock or run other apps, without changing the set timer.

All apps

Here you can find all the on the display installed apps.

PRE- INSTALLED APPS

	Aqua Mail:	A mail client for using your email account on the display.
	Browser:	For surfing the internet.
	Calculator:	For performing calculations, ranging from basic arithmetic to complex mathematics.
	Calendar:	For organizing your activities. Note: the calendar of your email account can be automatically linked when setting up your email account in Aqua Mail.
	Camera:	For taking photos or making videos, if a camera is attached.
	Clock:	For setting an alarm, showing the time, using a timer and stopwatch
	Eshare:	For wireless content sharing.
	File Commander:	For opening, editing, saving & sharing Word, PowerPoint, Excel and PDF files.*
	Office Suite:	A file manager to view your files, copy and paste content from your USB to the display and the other way around, link your cloud accounts or connect to a FTP Server or network.
	Store:	For searching and installing apps of your liking.
	UBoardMate:	A versatile whiteboard application.

* for the best performance we advise you to place the content on the display first.
For further explanation on how to use the pre-installed apps, please go to **support.ctouch.eu**.

SETTING MENU

NETWORK

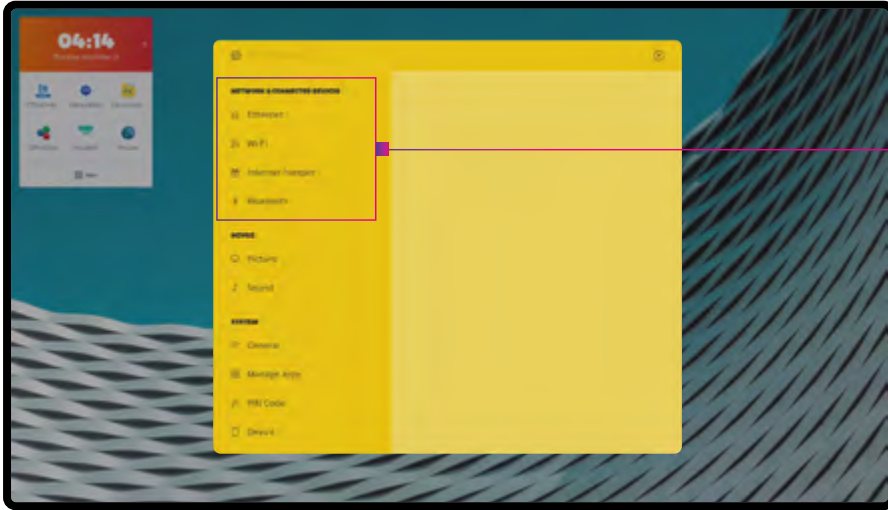

22

Network	Ethernet	Connect to Ethernet
	Wi-Fi	Connect devices with Wi-Fi
	Internet Hotspot	Set-up your local hotspot
	Bluetooth	Connect devices with Bluetooth

DEVICE: PICTURE & SOUND

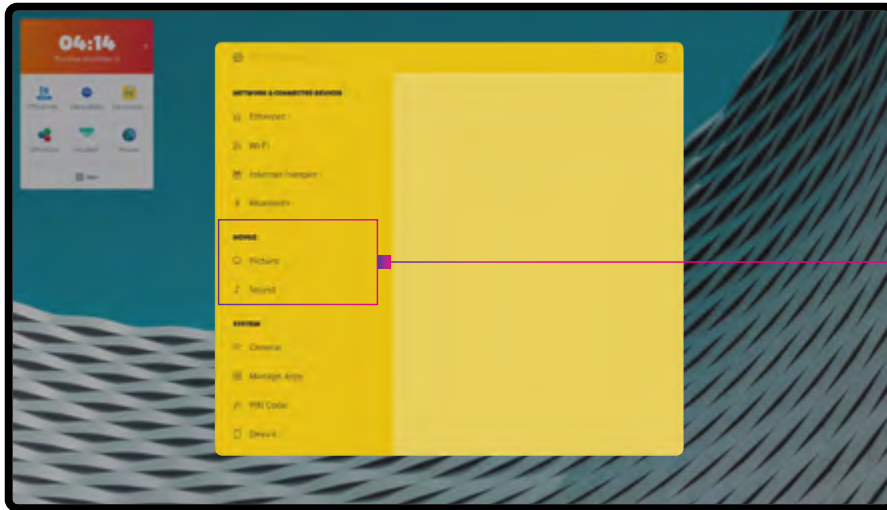

Picture	Energy mode	Select the energy mode of the display
	Zoom Mode	Select the aspect ratio (display proportions) according to your video signal type or personal preference
	Viewing experience	
	Picture mode	Select picture mode
	Colour profile	Select colour profile
	Backlight	Set the overall brilliance of the screen
	Eye protection	Set up eye protection - while writing the backlight will be automatically decreased for eye protection
	Blue light filter	Set the blue light filter
	Advanced	
	MEMC	Motion Enhancement, Motion Compensation - for a smoother image
PC mode	Image processing optimized specifically for attached PC input - only for HDMI	
Overscan	Adjust the reproduction ratio, you may activate this function to obtain a cleaner picture Note: Overscan is only adjustable when PC mode is off & the signal is under 4K resolution.	
VGA Auto adjust	Automatically adjust the image settings such as position and phase	
Sound	Sound mode	Select sound mode
	Media out device	Select the sound output
	Sound Quality	
	Balance	Adjust volume level of right and left speakers
	AVC	Select [On] to equalize overall volume levels across all channels Select [Off] to turn off the auto volume control
	Sound effect	Select the digital signal processing (DSP)
	SPDIF	
	SPDIF mode	Select the digital audio output mode for SPDIF
	SPDIF volume	Adjust SPDIF volume

SETTING MENU

SYSTEM

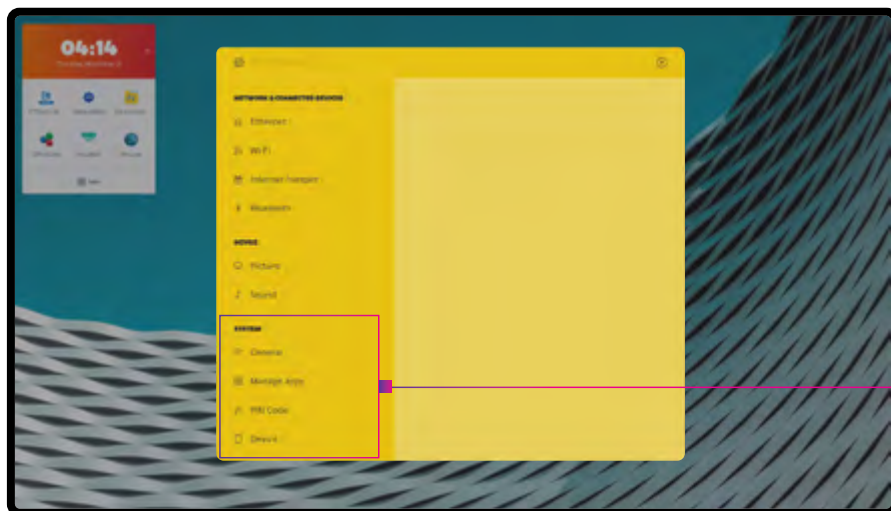

24

General	Home screen	Set the behaviour of the Home Button
	Languages	Select on-screen languages
	Keyboard & inputs	Select the settings of the on-board keyboard
	Date & time	Set the date & time used by the display
	Auto hide quick menu	Hide Float Bar after 8 seconds
	Wallpapers	
	Set wallpaper	Select the wallpaper of the COS source
	Set 'no input' wallpaper	Select the wallpaper of the 'no input' source
	Source Settings	
	Rename sources	Select the name of the source in the source bar
	HDMI settings	Set the settings of the HDMI sources
	Auto source switch	Switch automatically to a newly connected source
	Auto source back	Switch back to Home Source when the current source is disconnected
Power timings		
Timer off	Set Off Timer to switch the CTOUCH to standby at a specified day and time	
Timer on	Set On Timer to turn on the CTOUCH automatically on at a certain day and time	
Apps	-	Details about the installed apps
pin	Change pin code	Set pin code of the display - this pin code will be used for certain menu's & to lock the touch of the display
Device	System information	Details about the display, used storage and serial number of the display
	System updates	Update the display by using OTA or an USB-device
	Device reset	Reset the display to default settings PLEASE NOTE: this action cannot be undone!

TROUBLESHOOTING

For contact information and full warranty conditions refer to support.ctouch.eu. If, after reading these operating instructions, you have additional questions related to the use of your CTOUCH interactive display, please check the symptoms below and follow the suggested solutions. If you still have further questions, please visit support.ctouch.eu or call the services center in your local area. The number of the service center in your local area can be found on the the Warranty Card, which is included in the Accessory Box.

Remote Controle

25

PROBLEM	POSSIBLE SOLUTION
Remote control does not operate	<ul style="list-style-type: none"> ■ Make sure the CTOUCH interactive display is switched on ■ Check the direction of the batteries ■ The batteries could be low. Replace the batteries

Video and Audio

PROBLEM	POSSIBLE SOLUTION
No picture (screen not lit) and no sound	<ul style="list-style-type: none"> ■ Make sure the power cord is plugged in ■ Press POWER on the CTOUCH interactive display or on the remote control ■ Test another source
Dark, poor or no picture (screen lit) but good sound	<ul style="list-style-type: none"> ■ Select a proper picture mode ■ Adjust the brightness in the video setting ■ Test another source
No colour, dark picture or abnormal colour	<ul style="list-style-type: none"> ■ Adjust the colour saturation in the video setting
Good picture but no sound	<ul style="list-style-type: none"> ■ The sound may be muted. Press MUTE again to cancel ■ Verify if sound should output and/or test another source
Audio noise	<ul style="list-style-type: none"> ■ Communication problems may occur if infrared communication equipment (e.g., infrared cordless headphones) is used near the CTOUCH interactive display. Move the infrared communication equipment away from the CTOUCH until the noise is eliminated

TROUBLESHOOTING

General

PROBLEM	POSSIBLE SOLUTION
Some items can not be accessed	<ul style="list-style-type: none"> ■ If a setting option appears in grey, this indicates that the settings option is unavailable in current input mode. Some display menu items may be different when the unit works in different sources
Remote control command is not working in some cases	<ul style="list-style-type: none"> ■ During the timing of USB device detection (i.e. when the CTOUCH interactive display is turned on with USB device connected, or when you plug in USB device during the working of the CTOUCH), the display may not react on remote control buttons in such case. Wait a moment before the remote control should function again
Control buttons do not operate	<ul style="list-style-type: none"> ■ Disconnect the power cord and wait for a few seconds. Then re-plug the power cord and turn on the unit again
Touch does not work	<ul style="list-style-type: none"> ■ If you use an Apple-device, please download the Mac-driver from our website
Fog appear on the screen	<ul style="list-style-type: none"> ■ For the safety of screens, adding stalinite out of the screens. It is need to keep certain space between two layers for reserving air passages generate cross-ventilation and for insuring heat dissipation. Fog mainly comes from the temperature difference between the screen and the external. Moisture streaks congeal when hot air meets the low temperature glass surface The fog does not impact the normal use and it disappears after several-hour usage
Screen puts itself in stand-by mode as external device or Easy Air PC goes in sleeping mode	<ul style="list-style-type: none"> ■ Change the energy settings/sleeping-mode of the external device or Easy Air PC

26

Note: If your problem is not solved, turn off your unit and then on again.

Cautions! Never attempt to repair a defective CTOUCH interactive display yourself, as the warranty will void.

SPECIFICATIONS

MODEL NO.	CR-55X02	CR-65X02	CR-75X02	CR-86X02
Visible screen size	55 inch (diagonal)	65 inch (diagonal)	75 inch (diagonal)	86 inch (diagonal)
Power Source	AC 100-240V, 50/60Hz			
Current Max.	2.8 A	3.4 A	3.8 A	5.0 A
Default Power Consumption	95 W	124 W	151 W	194 W
Standby condition *	≤ 0.5 W	≤ 0.5 W	≤ 0.5 W	≤ 0.5 W
Number of pixels (Display panel)	3.840 x 2.160	3.840 x 2.160	3.840 x 2.160	3.840 x 2.160
Dimensions (W x H x D) (Unit: mm)	1.298 x 783 x 105	1.503 x 892 x 103	1.745 x 1.026 x 112	1.972 x 1.157 x 104
Weight	38 kg	46 kg	60 kg	73 kg
Operating conditions:				
- Operating temperature	5°C - 35°C			
- Storage temperature	-15°C - 45°C			
- Storage humidity	10% - 80%			
- Operating humidity	20% - 80% (no moisture condensation)			
- Atmospheric pressure	86kPa - 106kPa			

SPECIFICATIONS

CONNECTION TERMINALS OF THE CTOUCH INTERACTIVE DISPLAY	
HDMI In	3
DP (Display Port) In	1
USB-C (USB 3.1 Gen 2)	1
HDMI Out	1
VGA (incl. Mini Jack)	1
Mini Jack	1
SPDIF	1
USB 3.0	3
USB 2.0	2
Touch Out	3
RS232C	1
LAN	2
OPS slot	1
Wi-Fi slot	1
CTOUCH module slot	1
Dedicated port	3

27

Notes:

1. Design and specifications are subject to change without notice.
2. Weight and dimensions shown are approximate.
3. Specifications and external appearance may be changed for the sake of improvement.

*Due to different standby conditions, the standby power consumption of some models could be higher than 0.5W.

Changes or modifications void any warranty and exclude any liability. This user manual includes detailed instructions for your product. Figures and illustrations in this user manual are provided for reference only and may differ from actual equipment appearance. Equipment design and specifications may be changed without notice.

CTOUCH Europe BV - Achtseweg zuid 153 R, 5651 GW Eindhoven, The Netherlands

CTOUCH[®]

1456V200331 EN

Share, inspire, have fun!
With CTOUCH by your side.

ctouch.eu